

STOLKAR
SINCE 1989



CATALOGUE
2023
ARCHILINE



NEW COLLECTION

CHANGE YOUR INTERIOR WITH THE ARCHI LINE COLLECTION

When creating the Archi Line collection, our goal was to inspire and provide comprehensive interior design solutions - a collection that is matched to each other, thanks to which you can change your interior in a quick and cheap way.

The system we have designed offers virtually unlimited configuration possibilities.

The choice of the colour of the front, the body, the shape of the legs or the pattern - all thought out so that you can create your dream interior.

Hallway, living room, or maybe a bedroom? Where you use the panels and furniture of the Archi Line collection depends only on you.

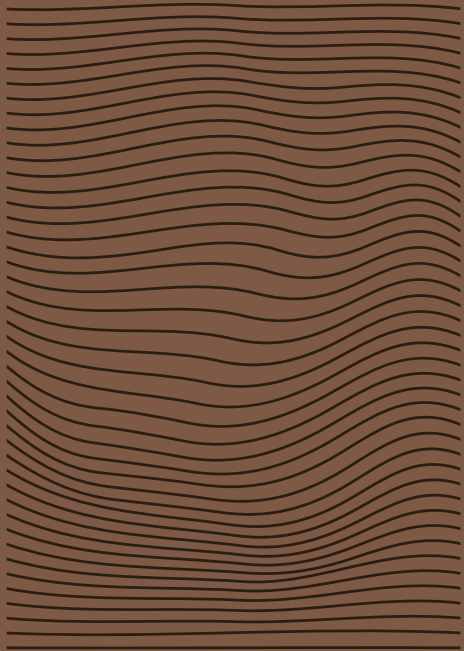

NEW COLLECTION

WALL PANELS & ROOM FURNITURE

Choose which Archi Line solution you want to use: wall panels or room furniture? Nothing prevents you from choosing and combining all the proposed options, because... why not?

Wall panels available in 5 patterns and 5 colours are perfect as decorative wall elements in a teenager's room, a bed headboard in your bedroom, a TV wall or a panel behind the sofa in the living room.

If the pattern is too much for you, choose plain panels, which you will also find in 5 colours.

Installation of the panels is very simple, you do not need a professional for this. You can do the interior metamorphosis yourself in a few moments!

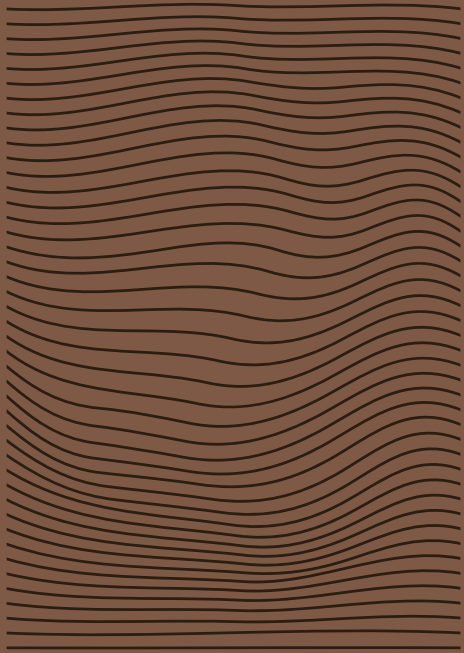

NEW COLLECTION

WALL PANELS & ROOM FURNITURE

We give you the opportunity to personalize your new furniture. Due to this, you can arrange your flat exactly the way you want it.

The base of Archi Line is 12 solids, which are available in 4 colours of bodies, and in 5 patterns and 5 colours of panels.

Your possibilities don't end there. You can decide for yourself whether you want a built-in, open or semi-open piece of furniture. It's up to you to choose whether to hang the furniture or put it up. If you decide on the second option, all you have to do is choose the appropriate legs...

You can assemble the furniture of the Archi Line collection yourself, using the assembly instructions.

PERSONALIZED SOLUTIONS

Design your individual interior by combining individual fronts that you can mix with each other in various ways. The personalization process allows you to modify the model so that it is ideally suited to your needs. You are able to influence such furniture parameters as: the colour and pattern of the front, the style of the legs or the colour of the body.



QUICK METAMORPHOSIS

Set yourself up for a great effect in the shortest possible time!

Thanks to the Archi Line collection, the metamorphosis of the interior will be pure pleasure. A simple way of assembling both panels and furniture will allow you to transform your apartment even in one weekend.

THE LATEST TRENDS

Our furniture is made of solid, Polish quality. They look great and work well for many years of use. They are always in fashion! In the Archi Line offer you will find almost unlimited possibilities in terms of style and arrangement of your space.

Get inspired!



NEW

panel collection

1 DIAMOND

2 GALENA

3 JASPER

4 AMBER

5 KLARO





DIAMOND

Treat yourself to a little sparkle in the original edition.

Small crystals combined with each other create a perfect whole, adding elegance and modernity to the interior. The Diamond pattern, maintained in current trends, will be perfect for both glamour-style interiors and modern or loft ones.

All you have to do is match the colour and Diamond will do the rest!

The panels are perfect as a TV wall, headboard of a bed or as a decorative element acting as a leitmotif for the entire interior. Remember that individual panel patterns and available colours can be freely combined with each other, thus creating a coherent interior.

Panel colour and pattern:

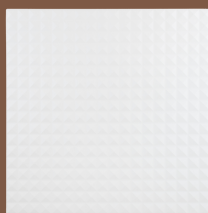

White semi-matte

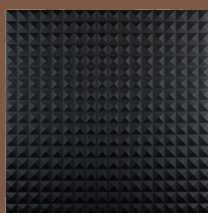

Black semi-matte

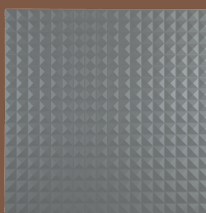

Gray matte

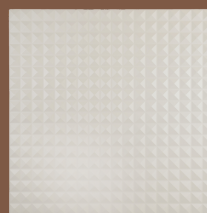

Beige gray matte

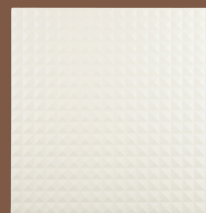

Cream matte



GALENA

Galena is called the stone of harmony, it allows you to free your thoughts, opens the mind and brings balance.

You can easily transfer all this to your interior.

All you have to do is choose the Galena panel pattern, which will connect all the elements of the room into a single, coherent interior like a guide. Use Galena to build a warm, soothing interior with an ideal relaxation and rest zone after a hard day.

Panels from the Archi Line collection are very easy to assemble. It only takes a moment to change the interior and give it a unique character.

Panel colour and pattern:



White semi-matte



Black semi-matte



Gray matte



Beige gray matte

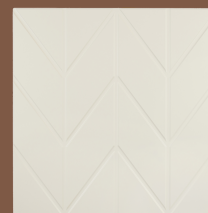

Cream matte



JASPER

The seemingly simple layout gives a lot of arrangement possibilities.

You can use Jasper panels to cover the entire wall or only a selected fragment, and by adding Klaro panels to the layout, you can create an original combination that will charm everyone.

The universality of the Jasper pattern makes them perfect as a TV wall or headboard in the bedroom. Depending on the color you choose, you can get a calm and delicate atmosphere in the room or give it a predatory and strong expression.

Remember that the panels perfectly match the furniture of the Archi Line collection!

Panel colour and pattern:



White semi-matte



Black semi-matte

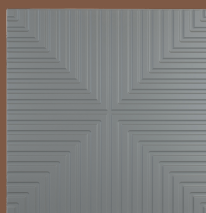

Gray matte

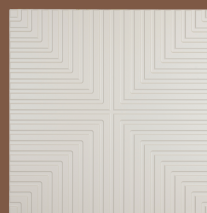

Beige gray matte

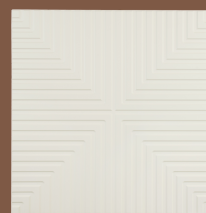

Cream matte



AMBER

Amber accumulates good energy and gives it to the environment, inspires optimism, changes the approach to the world.

Therefore, if you are looking for an arrangement that will express positive emotions, choose panels with the Amber pattern. The classic and modern line will perfectly fit into any interior and emphasize its unique character.

Amber panels can be combined vertically or horizontally, thanks to which you have a chance to get a completely different effect.

Let your imagination create your dream interior.

Panel colour and pattern:

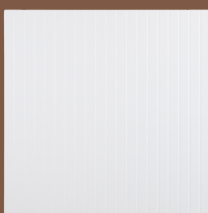

White semi-matte

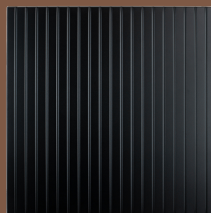

Black semi-matte



Gray matte

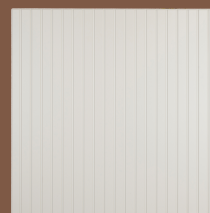

Beige gray matte



Cream matte





KLARO

Universal and timeless Klaro panels are a combination of a maximally smooth surface and subdued colours that will perfectly fit into your interior.

You can use them as a modern background for the furniture of the Archi Line series by building up a TV wall, creating an original interior of a teenager's room or arranging a separate zone for working at home.

Remember that the available colours of Archi Line perfectly harmonize with the colours of kitchen furniture that we offer. By choosing panels or Archi Line room furniture, you can easily combine the kitchen part with the living room, creating a coherent whole.

Have fun with colour and pattern. Design the interior according to your needs.

Panel colour and pattern:

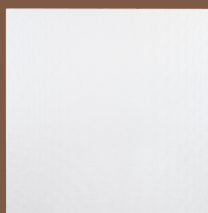

White semi-matte



Black semi-matte



Gray matte

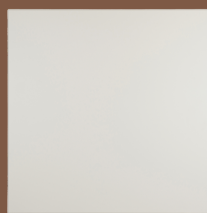

Beige gray matte

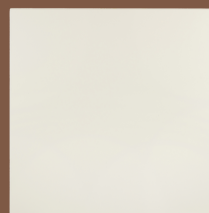

Cream matte



NEW furniture collection

- 1 TV CABINET 120
- 2 4X4 DRESSER
- 3 POST
- 4 A COFFEE TABLE 80
- 5 HANGING BOX
- 6 SEAT
- 7 DESK
- 8 CONTAINER
- 9 CONSOLE
- 10 TV CABINET 160
- 11 A COFFEE TABLE 120
- 12 BEDSIDE TABLE



RELAX ZONE

Build your dream relaxation zone where you can rest after a hard day or spend a nice time with your family and friends. Use Archi Line panels as a background for furniture that you create yourself. All you have to do is choose the body and its color, decide what front will be appropriate and ... ready!



HOME OFFICE ZONE

Life requires us to work together. That is why we give you the opportunity to match the furniture to your lifestyle. If you often work from home, it is worth having a suitable place for it. Archi Line is everything you need for work. In our collection you will find a desk with a mobile container, a post or hanging boxes.

SLEEP ZONE

A good night's sleep is the basis of a good day. That is why it is important that the zone where we rest is not only comfortable, but also pleasing to the eye. By choosing the Archi Line collection, you have at your disposal wall panels that perfectly fill the space above the bed, but also a dressing table or boxes that can serve as bedside tables.



HOW TO MAKE A PIECE OF FURNITURE FROM THE ARCHI LINE COLLECTION?

YOU CAN CHOOSE FROM

5 FRONT COLOURS



White semi-matte



Black semi-matte



Gray matte

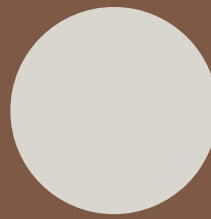

Beige gray matte



Cream matte

5 FRONT PATTERNS*

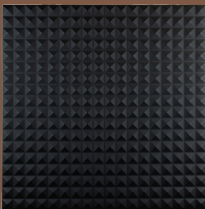

Diamond



Galena



Jasper

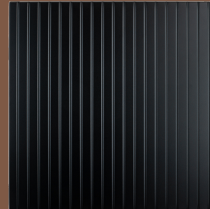

Amber

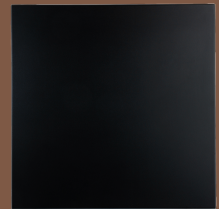

Klaro

*THE PANELS DO NOT CONTAIN HINGE HOLES.

HOW TO CREATE YOUR OWN PIECE OF FURNITURE FROM THE ARCHI LINE COLLECTION?

4 COLOURS OF THE BODY:



White

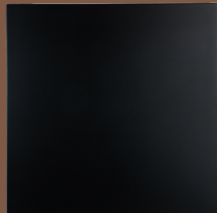

Black

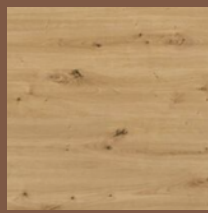

Aristan Oak



Sandy beige

8 VARIANTS OF LEGS:



150 mm



150 mm



150 mm



200 mm



600 mm



150 mm



51 mm



DESIGN IT

Create your new interior using the available furniture from the Archi Line collection. Combine individual modules, mix them with each other in various ways.

Change the colors and patterns of the fronts, getting exactly what your imagination tells you.



YOU HAVE 12 BLOCKS TO CHOOSE FROM:

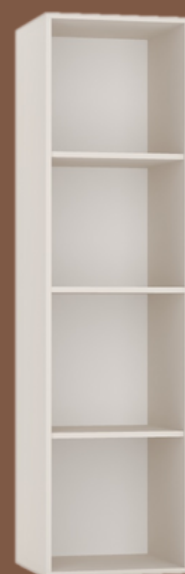

EXAMPLES OF OTHER MODIFICATIONS:

CHANGE THE PATTERNS



CHOOSE LAYOUTS



CHANGE COLOURS





DIMENSIONS

DESK

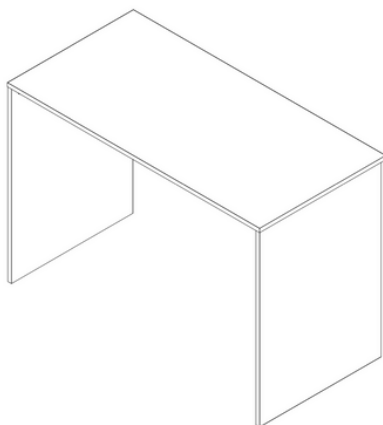

[SxWxG]
1100x750x550

CONTAINER

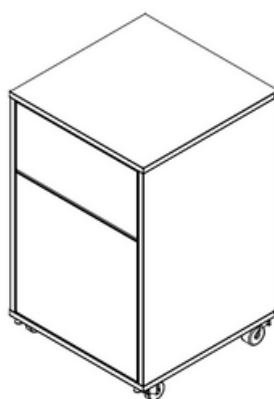

[SxWxG]
435x684x440

TV CABINET 120

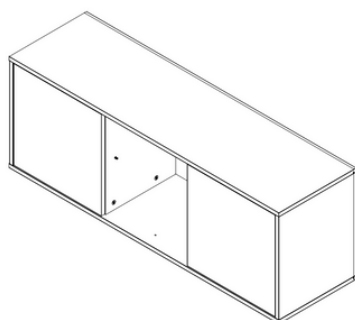

[SxWxG]
1221x434x350

CONSOLE

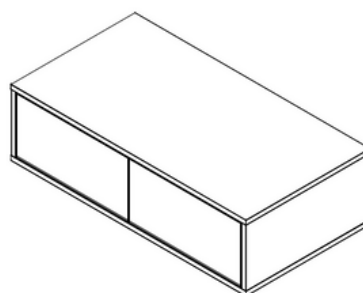

[SxWxG]
836x234x440

A COFFEE TABLE 120

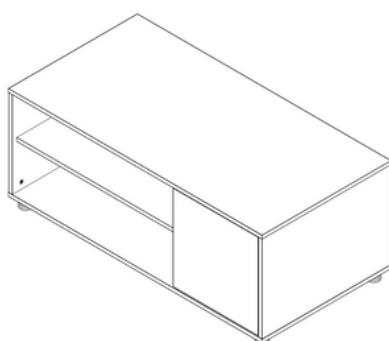

[SxWxG]
1180x460x600

A COFFEE TABLE 80

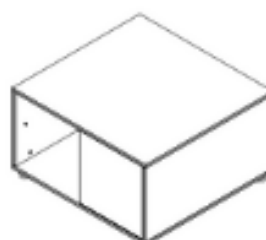

[SxWxG]
836x460x800



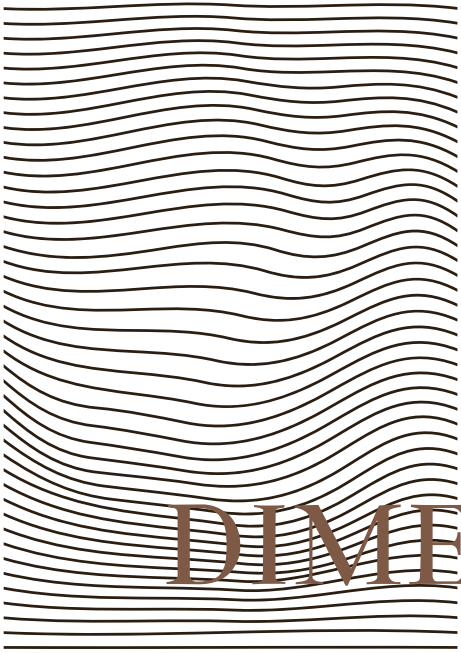

DIMENSIONS

SEAT

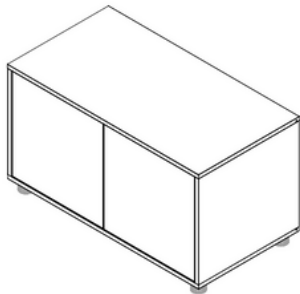

[SxWxG]
836x460x440

4X4 DRESSER

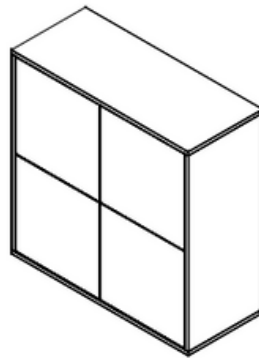

[SxWxG]
836x834x350

TV CABINET 160

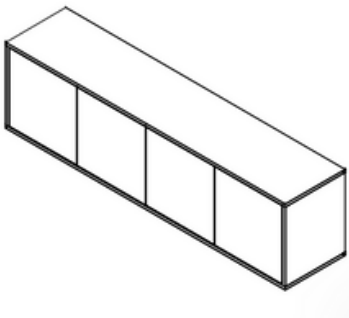

[SxWxG]
1636x434x350

POST



[SxWxG]
434x1636x350

BEDSIDE TABLE

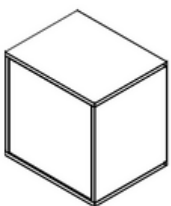

[SxWxG]
436x434x350

HANGING BOX

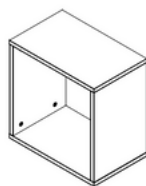

[SxWxG]
400x400x250

PANEL/FRONT

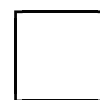

[SxW]
396x396

FRONT



[SxW]
198x396



CLICK ON THE PICTURE AND SEE THE ENTIRE APARTMENT

designed with the Archi Line collection



CLICK ON THE PICTURE AND SEE THE ENTIRE APARTMENT

designed with the Archi Line collection





WWW.STOLKAR.EN/ARCHLINE

**HAVE QUESTIONS?
CONTACT US!**

YOU CAN FIND US ON:

 @FabrykaMebliSTOLKAR / @StolkarFurnitureFactory

 @stolkar.pl / @stolkar.en

 @stolkar.pl

 @STOLKAR-DobreKuchnie